









ARMONIA

DATI TECNICI - REGINA

Potenza termica nominale		23 Kw
Potenza termica bruciata		25,3 Kw
Rendimento		90,9%
CO (13% O ₂)		674 mg/Nm ³
Polveri (13% O ₂)		16,5 mg/Nm ³
OGC (13% O ₂)		70 mg/Nm ³
NO _x (13% O ₂)		88,5 mg/Nm ³
Combustibile		Legna
Quantità di legna per carica		6 Kg
Temperatura fumi		242 C°
Portata fumi		20 g/s
Tubo uscita fumi		Ø 180
Tiraggio necessario		12 Pa
Raccordo presa aria comburente		Ø 150
Dimensione focolare		30x35x50(h) cm
Peso		522 Kg
Accumulo termico		8 h
Smart Fire		✓
Classe di qualità D.M. n. 186/2017		★ ★ ★ ★
Conto termico		✓
Classe di efficienza energetica		A+
Conforme alla legge austriaca 15 a B-VG		✓
Conforme alla normativa tedesca BimSchV2		✓
Conforme alla normativa Ecodesign 2022		✓
Conforme alla norma EN13229/A2		✓
Marchatura CE		✓

ARMONIA

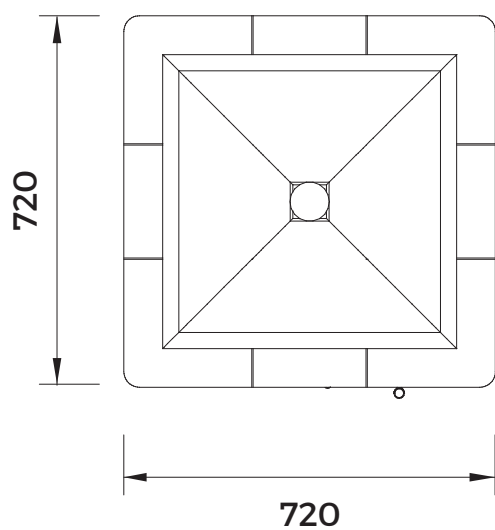
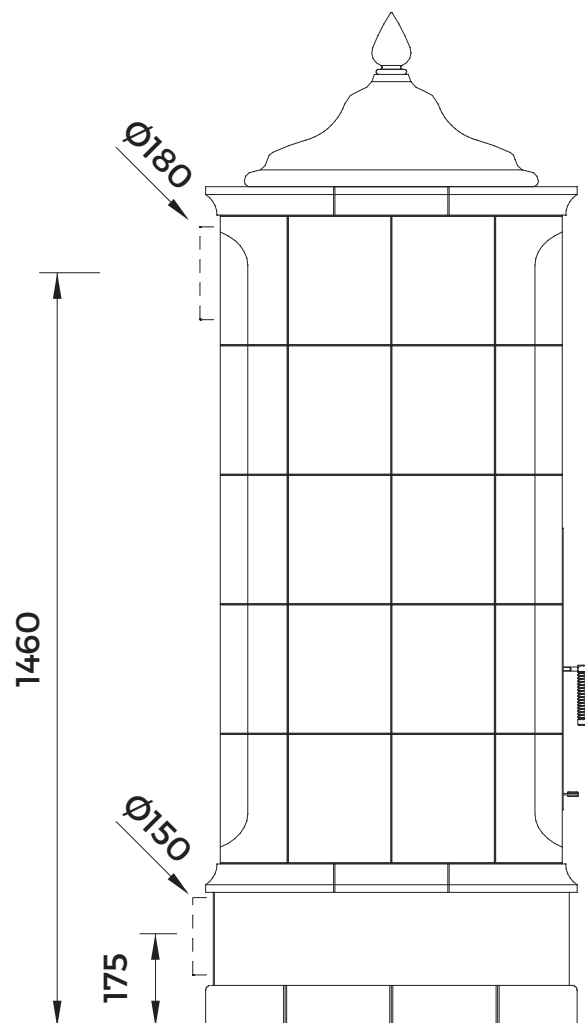
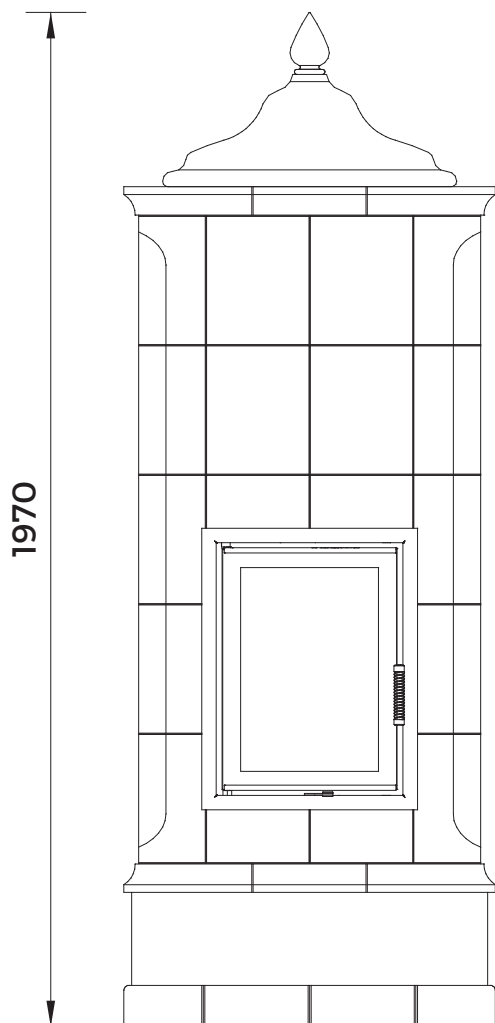

Tutte le quote sono espresse in millimetri